

BELLA FIGURA

Bodice Table Lamp

TL663

Collection Name

MOONLIGHT COLLECTION

The Bodice table lamp is the English Rose of this latest collection; a feminine personality composed of elegance and beauty with an unmistakably graceful demeanour. This table lamp is comprised of a mouth blown body of glass and a solid, spun brass neck, both deftly crafted in the south of England.

Finish note: This lamp finish is opaque; as these lamps are handmade by our artisans in England, they may vary from piece to piece in dimension and appearance.



TL663 in Raincloud and Polished Brass with a 12" Oval Shade in James Hare Aquila Moondust 31606/01

Available Finishes

Glass colours

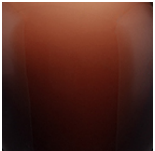

Mahogany



Ink

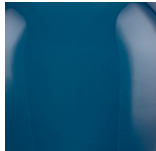

Nightwatch



Ballet



Raincloud

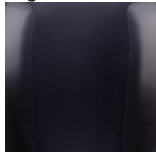

Storm

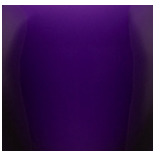

Indigo

Neck and Bulb Holder



Polished Brass



Pewter



Polished Silver



Antique Brass

Silk Flex Choice, Switch & Plug Colours

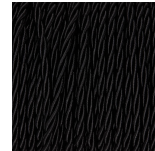

Black

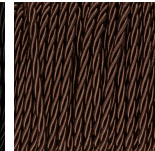

Brown



Cream



Silver

Available Sizes

One size only

TL663,

Height: 36.5 cm (14.37")

Diameter: 16 cm (6.3")

Depth: 12 cm (4.72")

Bulbs: 1 x 40w E27

Net Weight: 9 kg / 20 lb

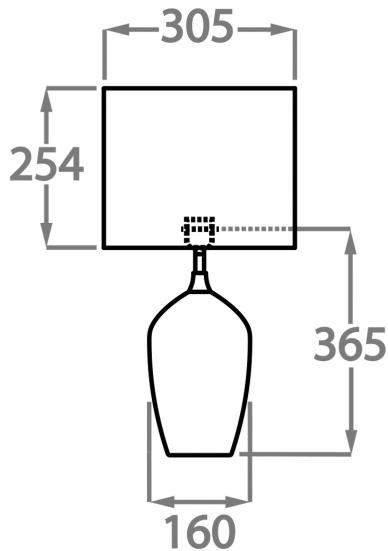

Dimensions are measured from the base of the lamp to the middle of the bulb holder and are excluding shade

The overall height with a 12" oval shade is 57cm

Finish note: As these glass lamps are handmade by our artisans in England, they may vary slightly from piece to piece in dimension and appearance